

LCD Preset Counters – Codix 923 (1 preset) / Codix 924 (2-6 presets)

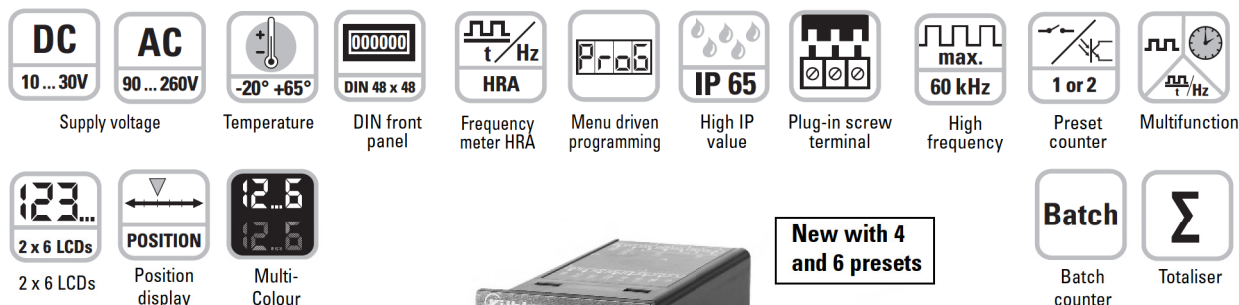

New with 4 and 6 presets



Multifunction:

- Counter, Tachometer and Timer – all in one device
- Can be used as preset counter, batch counter or totaliser (overall cumulative count)
- Presets: 923: 1, 924: 2, 924-4: 4, 924-6: 6
- Relay or optocoupler outputs
- Wide choice of count modes for pulse inputs, time or frequency
- Division factor, set value, averaging, start delay (Tachometer), step or tracking presets

Fast:

- Direct input of the presets via the front keys or the Teach-In input
- Fast installation thanks to plug-in screw terminals
- Max. count frequency 60 kHz

User-friendly:

- Simultaneous display of the actual value, presets, batch count or total count
- Annunciators for the displayed preset and for the output status
- 3 predefined settings for the most common parameter settings
- Direct entry into the programming
- Tracking presets eliminate the need for reprogramming of the pre-signal
- Minimum installation depth
- 4 stage RESET modes
- 3 stage key lockout
- Multicolour display for improved differentiation of the two values

Technical data:

Supply voltage:	90 ... 260 V AC/max. 8 VA, 50/60 Hz, External fuse protection T 0,1 A 10 ... 30 V DC/max. 1,5 W External fuse protection T 0,2 A
Display:	2 line 2 x 6 digits LCD display, upper line 9 mm, lower line 7 mm, special signs 2 mm high Standard: positive green with optional backlighting LED Look: negative, red backlighting Multicolour: upper line negative, red backlighting lower line negative, red or green backlighting (programmable)
Data retention:	min. 10 years, EEPROM
Inputs:	
Count inputs:	A and B
Polarity of the inputs:	programmable for all inputs in common NPN/PNP
Input resistance:	5 kOhm
Count frequency:	max. 55 kHz (details see manual)
Monitoring/reset inputs:	MPI, lock, gate, reset
Min pulse duration of the inputs:	10 ms/1 ms
Switching levels with AC-supply:	
HTL-level	Low: 0 ... 4 V DC High: 12 ... 30 V DC
5 V-level	Low: 0 ... 2 V DC High: 3,5 ... 30 V DC
Switching levels with DC-supply:	
HTL-level	Low: 0 ... 0,2 x UB High: 0,6 x UB ... 30 V DC
5 V-level	Low: 0 ... 2 V DC High: 3,5 ... 30 V DC
Pulse shape:	variable, Schmitt-Trigger characteristics

Output:	
Switching voltage	max. 250 V AC/110 V DC
Switching current	max. 3 A AC/A DC
Switching current	min. 30 mA DC
Switching capacity	max. 750 VA/90 W
Output 1	Mech. service life (switching cycles) 2 x 10 ⁷ N° of switching cycles at 3 A/250 V AC 1 x 10 ⁵ N° of switching cycles at 3 A/30 V DC 1 x 10 ⁵ Relay closing contact, programmable as normally open (NO) or normally closed (NC)
Output 2	Mech. service life (switching cycles) 20 x 10 ⁶ N° of switching cycles at 3 A/250 V AC 5 x 10 ⁴ N° of switching cycles at 3 A/30 V DC 5 x 10 ⁴ Relay with changeover contact
or npn optocoupler:	switching power 30 V DC/10 mA U _{CESAT} at IC = 10 mA: max. 2,0 V U _{CESAT} at IC = 5 mA: max. 0,4 V
Reaction time of the outputs:	Relay: appr. 10 ms Optocoupler: appr. 1 ms, Details see instruction manual
Response time of the frequency counter:	100/600 ms, Details see instruction manual
General:	
Count modes:	
Pulse counter:	cnt.dir, up.dn, up.up, quad, quad 2, quad 4, A/B, (A-B)/A x 100%
Frequency counter:	A, A-B, A+B, quad, A/B, (A-B)/A x 100%
Timer:	FrErun, Auto, InpA.InpB., InpB.InpB.

LCD Preset Counters – Codix 923 (1 preset) / Codix 924 (2 -6 presets)

Technical Data:

Voltage supply for sensors:		EMC:	Emitted interference:	EN55011 Class B
AC supply	24 V DC± 15%, 80 mA		Immunity to interference:	EN61000-6-2
DC supply	max. 80 mA, external voltage supply is connected through	Device safety:	design to:	EN61010 Part 1
			protection:	Class: 2
Operating temperature:	-20 °C ... +65 °C		application area:	Soiling Level 2
Storage temperature:	-25 °C ... +75 °C	Protection:	IP65 (front)	
Humidity:	RH 93% at +40 °C, non-condensing	UL (applied for):	File-N°.: E128604	
Altitude:	2000 m	Weight:	approx. 125 g	

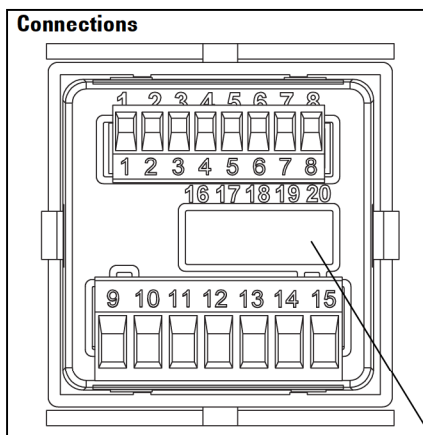
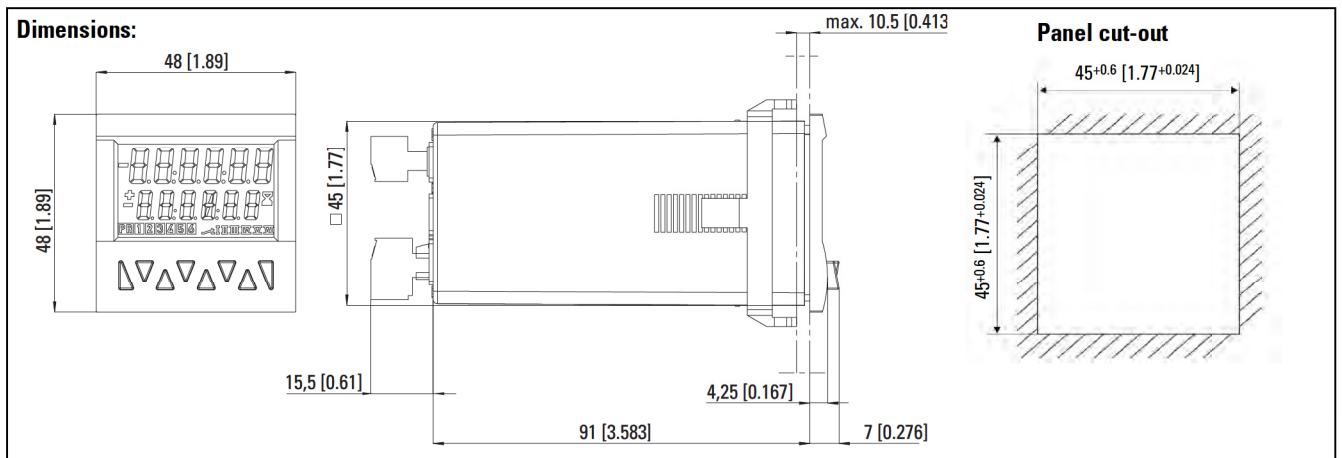

Signal and control inputs

- 1 Sensor voltage supply
AC: 24 VDC/80 mA
DC: UB interconnected
- 2 GND (0 VDC)
- 3 INP A (Signal input A)
- 4 INP B (Signal input B)
- 5 RESET (Reset input)
- 6 LOCK (Key locking input)
- 7 GATE (Gate input)
- 8 MPI (User input)
- 16 ... 20:
Additional optional inputs or outputs or interfaces

Version with relays/optocouplers

- 9 Relay contact C./Collector
 - 10 Relay contact N.O./Emitter
 - 11 Relay contact C./Emitter
 - 12 Relay contact N.O./not assigned
 - 13 Relay contact N.C./ Collector
 - 14 AC: 90..260 VAC N~
DC: 10..30 VDC
 - 15 AC: 90..260 VAC L~
DC: GND (0 VDC)
- Output 1 (9, 10)
Output 2 (11, 12)
Supply voltage (14, 15)

Additional connections 924-4 and 924-6



924-4

- 16 Relay contact N.C.4 Output 4
- 17 Relay contact C.4 Output 4
- 18 Relay contact N.O.4 Output 4
- 19 Relay contact N.O.3 Output 3
- 20 Relay contact C.3 Output 3

924-6

- 16 Common Emitter Output 3 to 6
- 17 Collector 6 Output 6
- 18 Collector 5 Output 5
- 19 Collector 4 Output 4
- 20 Collector 3 Output 3

LCD Preset Counters – Codix 924-4 (4 presets) / Codix 924-6 (6 presets)

Characteristics that differ from standard counters Codix 923/924:

The preset counters 924-4 und 924-6 vary from the standard counters 923 and 924 as follows:

- Relay version: 924-4, 4 presets, 2 additional relays
- Optocoupler version: 924-6: 6 presets, 4 additional optocoupler outputs
- no tracking presets

- Presets 1 and 4 affect the batch or total counter. Presets 2,3,5 and 6 (Type: 924-6) or presets 2 and 3 (Type 924-4) affect the main counter. Preset 2 is the main preset; it triggers the automatic reset.
- Preset 2 is likewise the main preset for all further counting modes. The other presets are pre-signals.

Technical Data:

Addendum Codix 924-4

Output 3, Relay with closing contact	
Switching voltage	max. 125 V AC/ 110 V DC
Switching current	max. 1 A AC/ 1 A DC min. 1 mA AC/DC
Switching capacity	max. 62,5 VA/ 30 W
Mech. service life (switching cycles)	5x10 ⁷
N° of switching cycles at 0.5A/125 VAC	1x10 ⁵
N° of switching cycles at 1 A/30 V DC	1x10 ⁵
Output 4, Relay with changeover contact	
Switching voltage	max. 125 VAC/ 110 VDC
Switching current	max. 1 A AC/ 1 A DC min. 1 mA AC/DC
Switching capacity	max. 62,5 VA/ 30 W
Mech. service life (switching cycles)	5x10 ⁷
N° of switching cycles at 1 A/110 V AC	1x10 ⁵
Reaction time of the outputs: Relay (only impulse and time counter)	< 7 ms
Max. count frequency:	50 kHz

Addendum Codix 924-4

Output 1 to 6, NPN optocoupler	
Switching capacity:	30 V DC/10 mA
U _{CESAT} at IC = 10 mA:	max. 2,0 V
U _{CESAT} at IC = 5 mA:	max. 0,4 V
Output 3, 4, 5 and 6 with common emitter	
Reaction time of the outputs, optocoupler: (only impulse and time counter)	
Add/Sub/	< 1 ms
with auto repeat	< 1 ms
A/B ; (A-B)/A	< 23 ms
Max. count frequency:	50 kHz

Order code:

6.92X.01XX.XXX

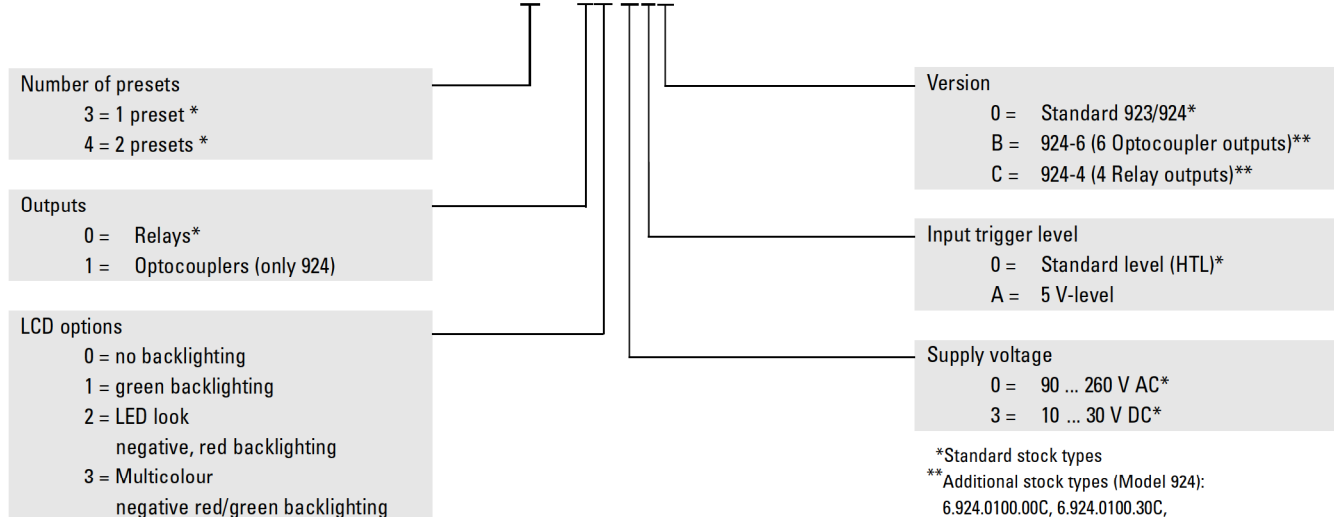

Accessories:

Adapter front bezel 55 x 55 mm for panel cut-out 50 x 50 mm
Order code: T00885
Gasket order code: N511004

Adapter front bezel 60 x 75 mm with screw fixing
Order code: T008860
Gasket order code: N511028

Replacement parts:

8-pin connector 1 ... 8: N100498
7-pin connector 9 ... 15: N100548u002 (for 923/924)
7-pin connector 9 ... 15: N100400u002 (for 924-4/924-6)
5-pin connector 16 ... 20: N100399u002

*Standard stock types

**Additional stock types (Model 924):

6.924.0100.00C, 6.924.0100.30C,
6.924.0113.00B, 6.924.0113.30B

Options: Additional inputs, outputs or interface types on request.

Delivery specification:

Preset counter
Mounting clip
8-pin screw terminal
7-pin screw terminal
Operating instructions

Areas of application:

■ Pulse counter

Functions/ Count modes

- Count with direction mode
- Difference mode
- Quadrature mode quad/quad2/quad4
- Add, Sub, automatic reset
- 2-input adding mode A+B
- Ratio measurement A/B
- Percentage difference measurement $(A-B)/A \times 100\%$
- Batch counting
- Totaliser (Overall total)
- Multiplication and division factor (up to 99,9999)
- Set value
- Step or tracking preset

<h3>Application examples</h3>	<p>CountDir + Add Roller shutter door with automatic shut-off</p>	<p>Quad + Add Running direction and position on milling machines, Limit switch monitoring</p>
	<p>UpDown + Add Automatic subtraction of faulty or reject parts from the total piece count</p>	<p>CountDir + Batch Logging of piece numbers and packing units plus control of replenishment of packing cartons</p>
	<p>UpUp + Add Adding up of two parallel or staggered production lines</p>	<p>Quad + Add tot Cut-to-length with overall total count and control of the machine</p>

Areas of application:

■ Frequency meter (Tachometer)

Functions/ Count modes

- A
- A - B
- A + B
- A / B
- $(A - B) / A \times 100 \%$ (percentage display)
- Quad (phase discriminator with recognition of direction)
- Averaging
- Start delay
- 2nd tacho input
- Gate input
- Multiplication and division factor (up to 99,9999)

Application examples

A - B

Synchro monitoring and control of two conveyor belts

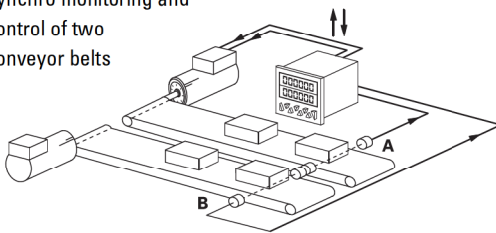

Quad

Speed regulation with indication of direction

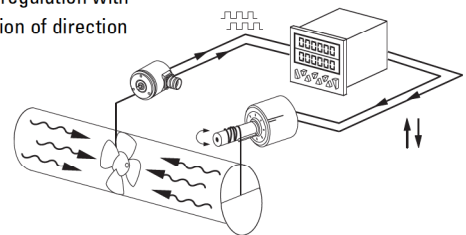

A/B

Ratio measurement

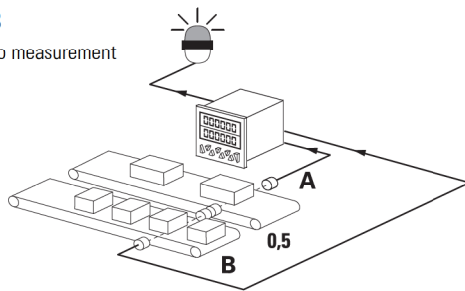

$(A-B)/A$ [%]

Ratio measurement, e.g. for speed alignment

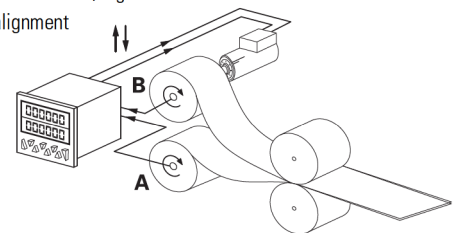

■ Time and Hours-run meter (Timer)

Functions/ Count modes

- FrErUn (Control via gate input)
- Auto (Start via Reset, Stop at Preset)
- InpB.InpB (Start with first edge at InpB., Stop with second edge InpB.)
- InpA. InpB (Start with InpA., Stop with InpB.)
- Totaliser (Overall total)
- Batch counting
- Set value
- Step or tracking preset

Application examples

Interval measurement InpB. InpB

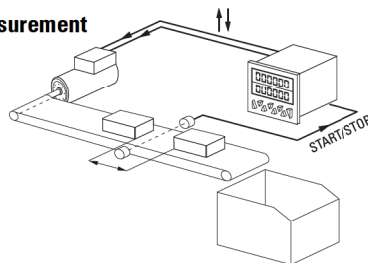

FrErUn

Measurement of overall time from switching on the conveyor belt till switching off

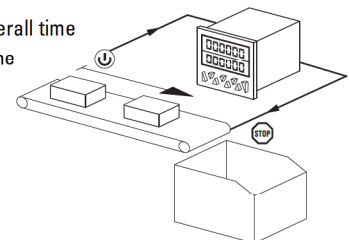

Run-time measurement InpA. InpB.

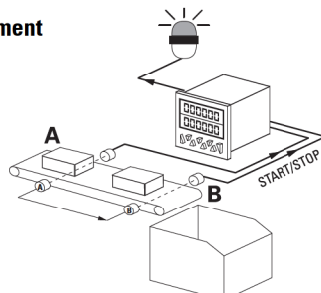

Auto

Time-controlled production line

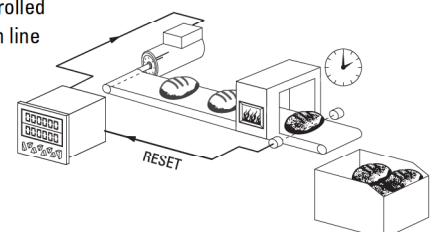

The technology platform for OEM applications:

Expandable hardware

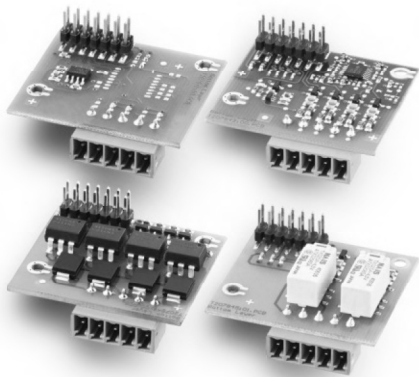

- Expandable on request via modules:
- 4 additional inputs
 - or 4 additional optocoupler outputs
 - or 2 additional relay outputs
 - or RS 232/485 communications interfaces

- Application examples:
- Limit switch monitoring
 - Special functions/PLC function
 - Initiation of fixed program sequences
 - Control of several processes
 - Special protocols
 - Print commands for logging

Customisable software

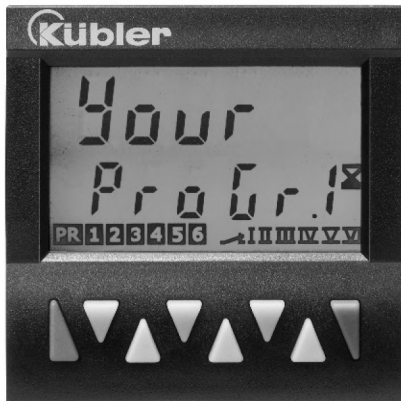

Individual customisation of software to your application. For example:

- Separate inputs for total counter and preset counter
- Separate scaling of input A and B
- Programmable measuring period for the tachometer
- Measurement of rotary speeds based on time
- Processing time, measurement of time based on frequency
- With the Multicolour version, the display colour changes when reaching the preset, or blinking display with all versions

Please talk to us – we look forward to solving your individual requirements in a close dialogue with you